

**Operating and mounting description**

**CL 2400 Fresh air inlet**

Code No. 99 97 1110

Edition 03/99 M 1110 GB



<b>1</b>	<b>Types of fresh air inlets</b>	<b>3</b>
1.1	CL 2400 Z	3
1.2	CL 2400 N	5
<b>2</b>	<b>General description CL 2400</b>	<b>7</b>
2.1	Air capacities	7
2.2	Air inlet dimensions	8
<b>3</b>	<b>Dimensioning</b>	<b>9</b>
3.1	Fresh air inlet	9
3.2	Air outlet	9
3.3	Additional air outlet	9
3.4	Dimensioning and positioning of air inlets	10
<b>4</b>	<b>Assembly diagram and description of parts</b>	<b>12</b>
4.1	CL 2400 Z	12
4.1.1	Parts Reference:	13
4.2	CL 2400 N	14
4.2.1	Parts Reference:	15
<b>5</b>	<b>Parts lists</b>	<b>16</b>
5.1	CL 2400 Z	16
5.1.1	incl. net	16
5.1.2	excl. net	16
5.1.3	Roller tube	17
5.2	CL 2400 N	18
5.2.1	incl. net	18
5.2.2	excl. net	18
5.2.3	Mounting set	19
5.2.3.1	Detailed drawing of the assembly kit accessories	20
5.2.3.2	Assembly of idler pulleys with different strains	21



## 1 Types of fresh air inlets

### 1.1 CL 2400 Z

- The flap is kept closed by means of tension springs.
- Precise adjustment
- The flaps do not jam = guaranteed opening
- Since the adjustment device is located below the fresh air inlets it is much easier to mount or access them as in the case of baffle flaps where the adjustment device is located above the flaps, particularly as the fresh air inlet flaps are installed at a very high level at the side walls in case of cage systems.
- The adjustment is done via a continuous 1" pipe which is rotated by a 230 Volt servomotor with response potentiometer.
- The nylon rope of the fresh air inlets is coiled up.

#### Advantages:

- does not depend on constructional conditions; no need to avoid or drill through beams, girders etc;
- very safe, as no rope can tear;
- every fresh air inlet can be adjusted quickly and easily.
- each side of the house or each row of fresh air inlet elements respectively requires one servomotor which should be installed in the centre of the house.
- The 1" pipe is conducted in galvanized iron bearings with bronze ring (in intervals of 3, 4, 5 m).

Figure 1-1:CL 2400 Z

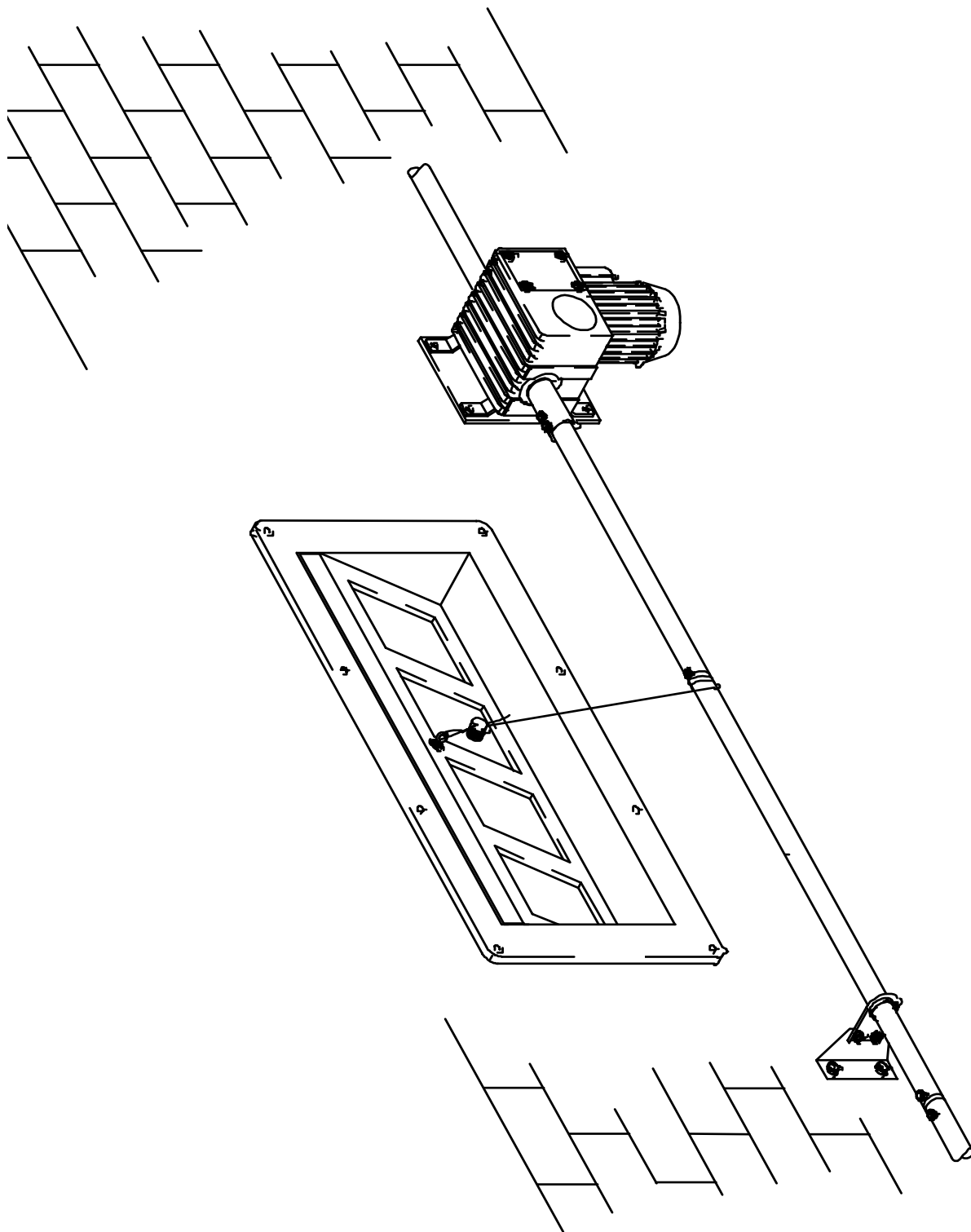

## 1.2 CL 2400 N

The flap is closed by the servomotor; it is opened by its own weight and by releasing the traction rope.

- Adjustment is done via a continuous rod wire and traction string which are pulled by a servomotor with response potentiometer.
- Should a traction string tear, the respective fresh air inlet element opens completely.
- The tension rod should be inserted through eyelet bolts and the traction strings are diverted through the same.

Advantages:

- Just one servomotor is required for smaller installations.
- 1 x CL 75 A/3 up to 40 fresh air elements
- 1 x CL 75 A/6 up to 80 fresh air elements

Figure 1-2:CL 2400 N

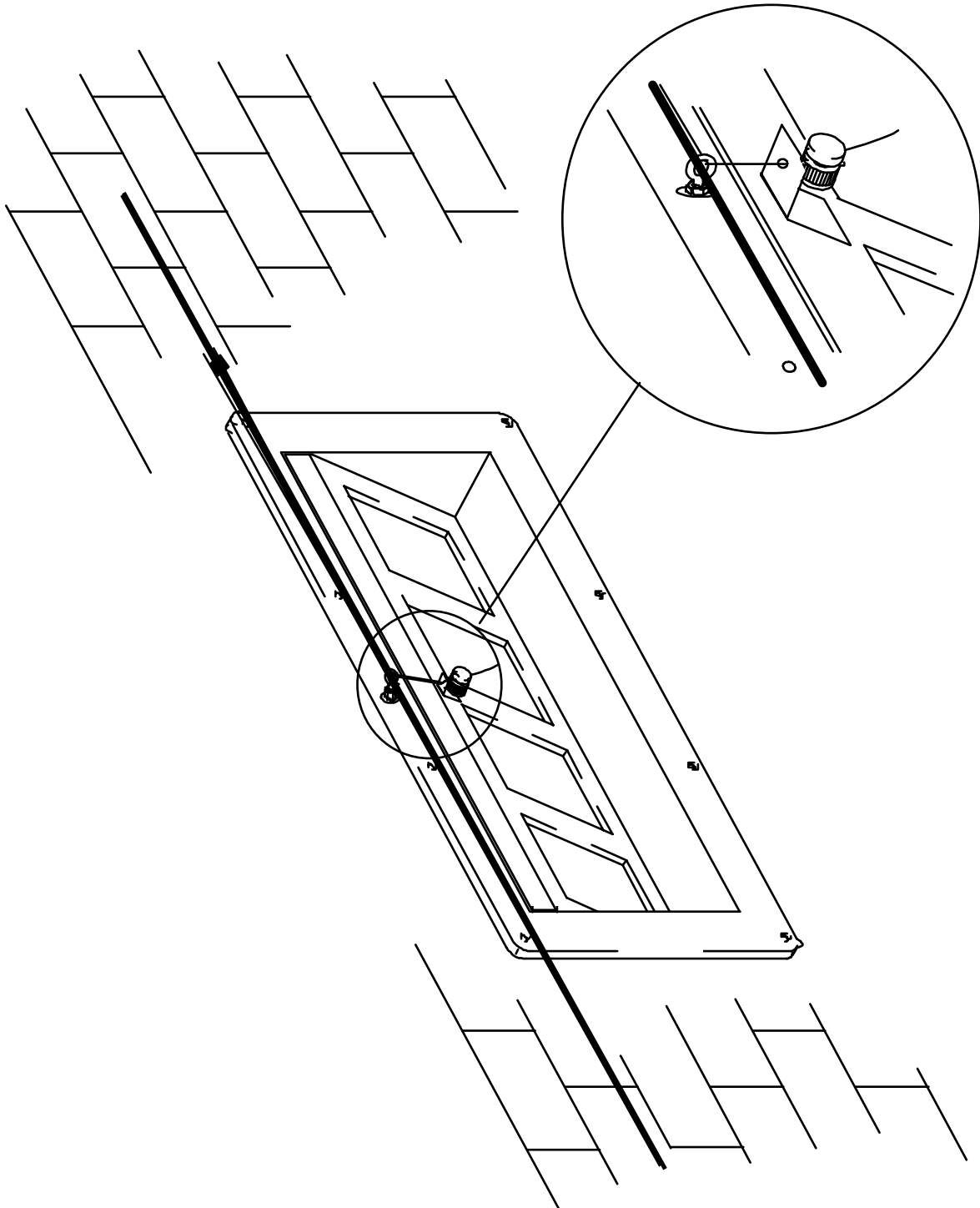

## 2 General description CL 2400

- Application in cage houses where the installation of baffle or split baffle flaps would be difficult or impractical and very expensive.
- We ourselves have found air inlet elements in cage houses completely satisfactory.
- Additional large air inlet blinds for longitudinal / tunnel ventilation (SMT-48 blind) have proven their worth on summer days with temperatures exceeding 26 °C.
- Alternatively, a second row of air inlet elements could be installed below the intermediate ceiling in high installations with 6 to 8 levels.
- Another important application is the use in cage houses with combi-tunnel ventilation where normally the traditional ventilation, i.e. lateral air inlet flaps are used, but - with outer temperatures reaching higher levels - the system would switch to tunnel ventilation (longitudinal ventilation) with its own air inlet while the lateral flaps, i.e. the air inlet elements, must be closed completely and airtight.

### 2.1 Air capacities

(max. free opening section = 0.2400 m<sup>2</sup>)

- 10 Pa	=	2,400 m <sup>3</sup> /h
- 20 Pa	=	3,400 m <sup>3</sup> /h
- 30 Pa	=	4,100 m <sup>3</sup> /h
- 40 Pa	=	4,800 m <sup>3</sup> /h

## 2.2 Air inlet dimensions

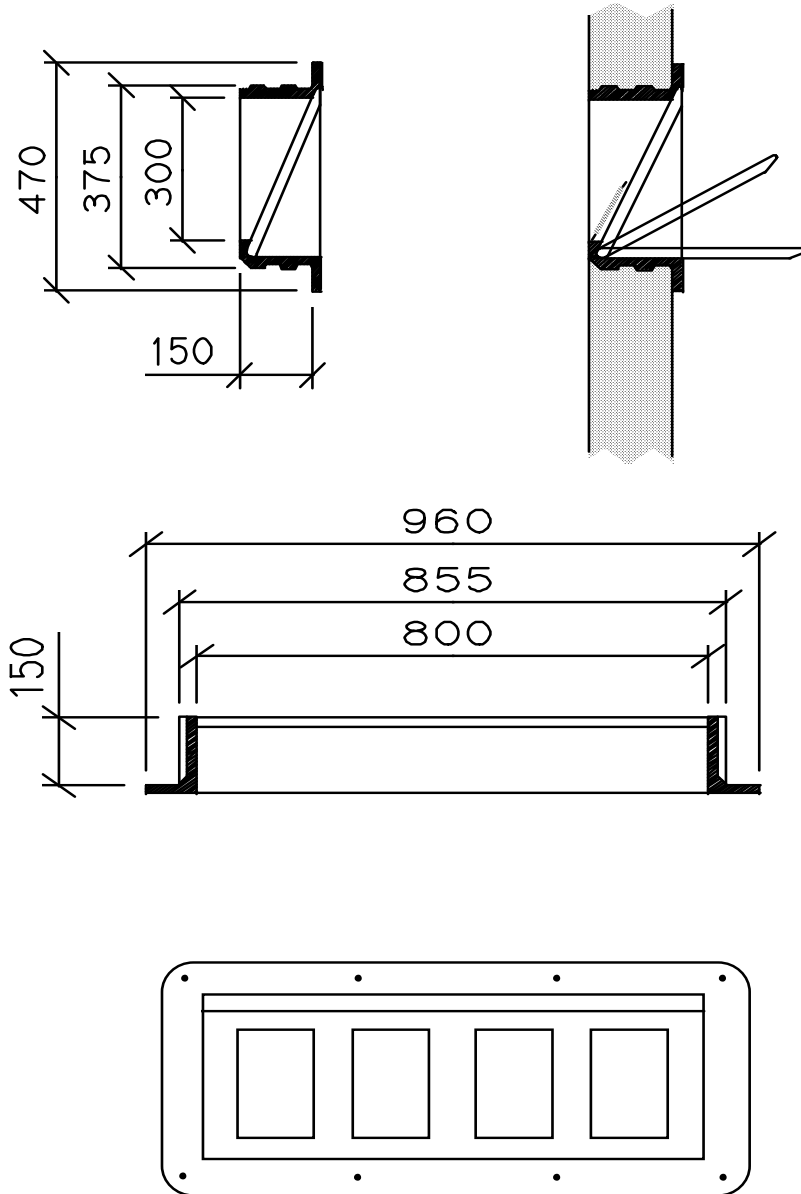

## 3 Dimensioning

### 3.1 Fresh air inlet

- 4 m<sup>3</sup>/h per laying hen (with a depression of - 10 Pa)

**generally: one valve per 600 laying hens**

- 3 m<sup>3</sup>/h per pullet (with a depression of - 10 Pa)

**generally: one valve per 800 pullets**

### 3.2 Air outlet

Depending on the climatic zone the max. outlet capacity is 6 m<sup>3</sup>/h, 8 m<sup>3</sup>/h or 10 m<sup>3</sup>/h.

Accordingly, the depression and thus the "air capacity" of the wall inlets will increase.

Example: 40.000 laying hens x 4 m<sup>3</sup>/h = 160.000 m<sup>3</sup>/h (- 10 Pa)

→ 160.000 m<sup>3</sup>/h : 2400 m<sup>3</sup>/h (- 10 Pa) = **66 CL-2400 units**

### 3.3 Additional air outlet

In case additional air inlet openings are installed for the summer, the air inlets can be calculated on the basis of 15 Pa (3000 m<sup>3</sup>/h) instead of 10 Pa (2400 m<sup>3</sup>/h)

i.e. the number of air inlet elements is reduced by 25%

Example: 40.000 laying hens x 4 m<sup>3</sup>/h = 160.000 m<sup>3</sup>/h

→ 160.000 m<sup>3</sup>/h : 2400 m<sup>3</sup>/h (- 10 Pa) = 66.7 CL-2400 inlet elements

66.7 air inlet elements minus 25% = **50 CL-2400 units**

### 3.4 Dimensioning and positioning of air inlets

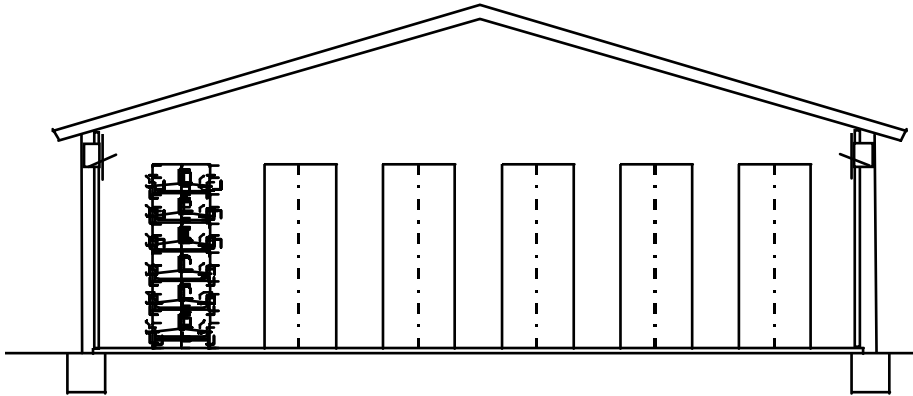

Figure 3-3: Jet ventilation: one row of air inlets per side

For houses without intermediate ceiling

- valves to be mounted preferably above the cage rows
- max. depression: 40 Pa

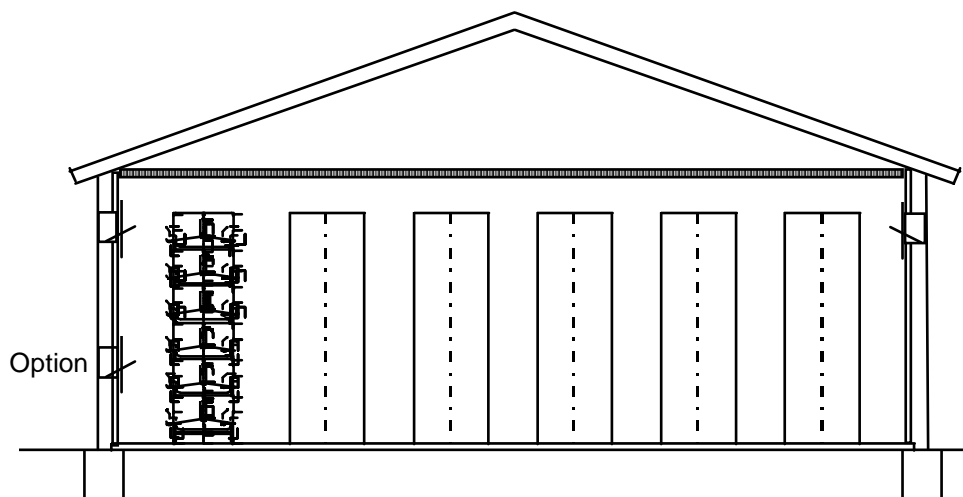

Figure 3-4: diffuse ventilation: one row of air inlets per side

- Installation height: upper edge of the inlet = upper edge of the cages
- max. depression: 20 Pa
- optional 2nd row of air inlets for additional summer ventilation

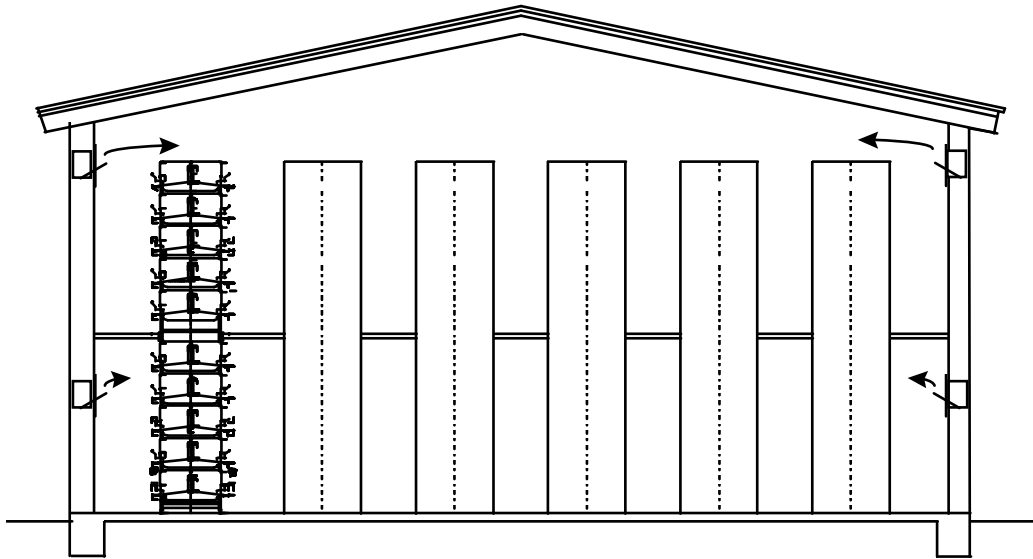

Figure 3-5: Jet ventilation: two rows of air inlets per side

- for cages with catwalk -
- upper row preferably above the cages
- lower row below the catwalk
- with max. outlet capacity = max. depression 20 Pa
- winter ventilation (only upper row is open) = max. depression 30 Pa

### 4 Assembly diagram and description of parts

#### 4.1 CL 2400 Z

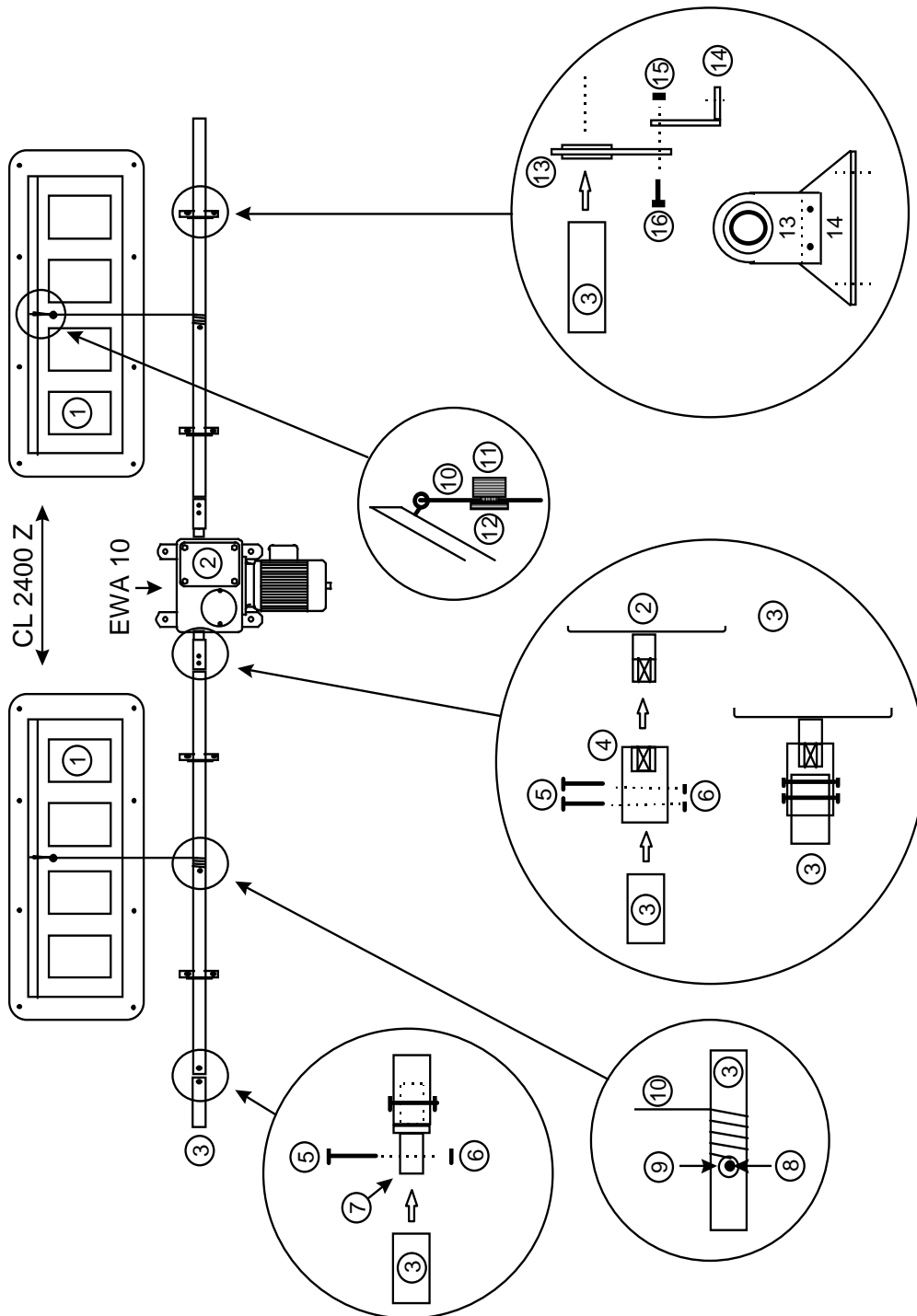

Figure 4-6:

#### 4.1.1 Parts Reference:

1. Air inlet CL 2400 Z
2. Electric shaft driving mechanism EWA 10, 230 Volt with response potentiometer  
Code No. 60503205
3. Roller tube 1" x 6000 complete for CL 2400 Z air inlets
4. Coupler for the connection between motor and roller tube (provided with motor)
5. Hexagon screw M8 x 45 galv. DIN 558
6. Self-locking counternut M8, DIN 985-6, galv.
7. Galv. coupler for 1" tube
8. 4.8 x 16 drill screw, DIN 7504-L
9. Washer flat A 5,3 x 15 x 1.5 DIN 9021 galv.
10. PP string, 3 mm white
11. PE nut for rope
12. PE plug for rope clamp without nut
13. Plain bearing plate galv. H = 70 mm for tube 1"
14. Mounting plate for plain bearing plate B 1"
15. Hexagon screw M6 x 12 galv. DIN 558
16. Hexagon nut M6 galv. DIN934-8

**The number of roller tubes 1"x6000, galv. compl. (Code No. 60 50 3210) must be calculated on the basis of the house dimensions.**

### 4.2 CL 2400 N

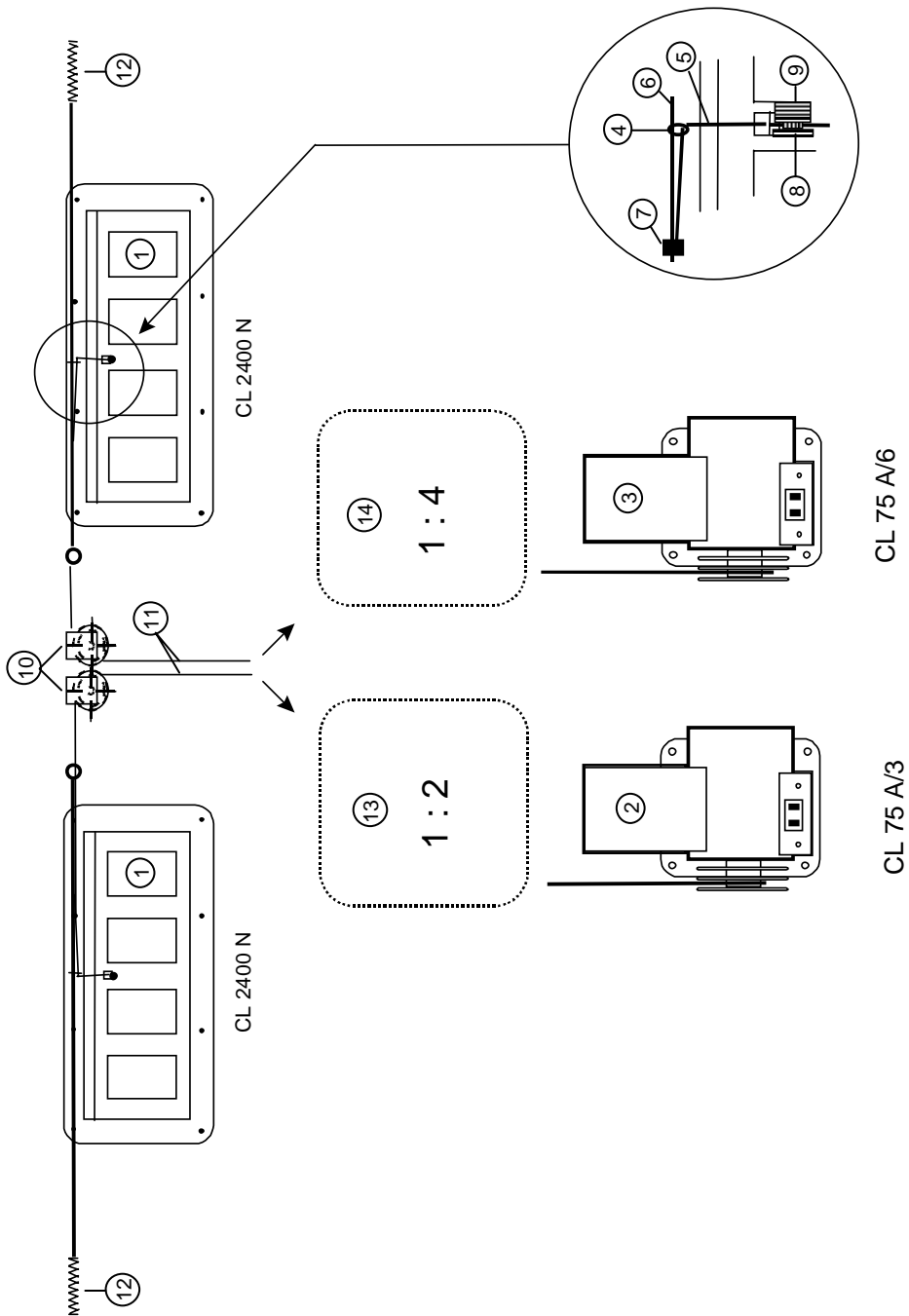

Figure 4-7:

#### 4.2.1 Parts Reference:

1. Air inlet CL 2400 N
2. Winch motor CL - 75 A- 3 with response potentiometer Code No. 60 43 2043
3. Winch motor CL - 75 A- 6 with response potentiometer Code No. 60 43 2044
4. Wood screw ring galv. 2/50 x 18 x 7.0
5. Traction rope 3 mm white
6. Rod wire 5 x 5000 galv.
7. Cable clamp 5 mm 3/16" galv. DIN 741 Traction spring 3.0 x 39 x 187 (must be pretensioned to a total length of 300 mm with the flap being completely open)
8. PE plug for string without nut PP string 3 mm white
9. PE nut for string
10. Idler roller PVR 107 mm
11. Traction rope (premounted at the winch motor)
12. Pull-back spring
13. Preferable transmission 1:2 Ease away length approx. 40 cm = 11 windings
14. Preferable transmission 1:4 Ease away length approx. 40 cm = 12 windings

**One assembly kit CL 2400 N (Code No. 60 47 3385) is required  
for each motor.**

**The required quantity of rod wire 5 x 5000 (Code No. 37 81 1004) must be  
calculated on the basis of the house length.**

## 5 Parts lists

### 5.1 CL 2400 Z

#### 5.1.1 incl. net

60-47-3374				Fresh air inlet cpl CL-2400-Z incl. netz
	Quantity	Unit	Code No.	Description
1	1	pc	60-47-3389	Fresh air inlet CL - 2400 - Z incl. net
2	0.40	pc	99-50-3810	Silicone transparent 300 ml
3	8	pc	99-10-3958	Chipboard screw 5,0 x 50 ABC-Spax pan head SST
4	8	pc	99-98-3782	Dowel S 6
5	1.20	m	99-50-1004	Rope Perlon 3 mm white
6	1	pc	30-61-3485	Plug PE for rope clamp wo/nut
7	1	pc	30-61-3486	Nut PE for rope clamp
8	1	pc	99-10-3882	Drilling screw 4,8 x 16 DIN 9021 galv.
9	1	pc	99-20-1003	Washer flat A 5,3 x 15 x 1,5 DIN 9021 galv.

#### 5.1.2 excl. net

60-47-3375				Fresh air inlet cpl. CL 2400 Z excl. net
	Quantity	Unit	Code No.	Description
1	1	pc	60-47-3375	Fresh air inlet CL - 2400 - Z excl. net
2	0.40	pc	99-50-3810	Silicone transparent 300 ml
3	8	pc	99-10-3958	Chipboard screw 5,0 x 50 ABC-Spax pan head SST
4	8	pc	99-98-3782	Dowel S 6
5	1.20	m	99-50-1004	Rope Perlon 3 mm white
6	1	pc	30-61-3485	Plug PE for rope clamp wo/nut
7	1	pc	30-61-3486	Nut PE for rope clamp
8	1	pc	99-10-3882	Drilling screw 4,8 x 16 DIN 9021 galv.
9	1	pc	99-20-1003	Washer flat A 5,3 x 15 x 1,5 DIN 9021 galv.

**5.1.3 Roller tube**

<b>60-50-3210</b>			<b>Roller tube 1"x6000 galv. cpl. for CL-2400-Z</b>	
	Quantity	Unit	Code No.	Description
1	1	pc	99-40-3813	Pipe 1"x6000 galv. DIN 2440
2	1	pc	60-50-3207	Coupler galv. for tube 1"
3	2	pc	99-10-1207	Hexagon head screw M8 x 45 galv. DIN 558
4	2	pc	99-20-1064	Self-locking counter nut M8 DIN 985-6 galv.
5	2	pc	60-50-3206	Plain bearing plate galv. H=70mm for tube 1"
6	2	pc	99-10-3719	Hexagon wood screw 6 x 60 galv. DIN 571-ST
7	2	pc	99-98-3781	Dowel S 8
8	2	pc	99-50-3175	Mounting plate for plain bearing plate B 1"
9	4	pc	99-10-1100	Hexagon head screw M6 x 12 galv. DIN 558
10	4	pc	99-10-1045	Hexagon nut M6 galv. DIN 934-8

## 5.2 CL 2400 N

### 5.2.1 incl. net

60-47-3372				Fresh air inlet cpl. CL 2400 N incl. net
	Quantity	Unit	Code No.	Description
1	1	pc	60-47-3377	Fresh air inlet CL - 2400 - N incl. net
2	0.40	pc	99-50-3810	Silicone transparent 300 ml
3	8	pc	99-10-3958	Chipboard screw 5,0 x 50 ABC-Spax pan head SST
4	8	pc	99-98-3782	Dowel S 6
5	1.20	m	99-50-1004	Rope Perlon PP 3 mm white
6	1	pc	30-61-3485	Plug PE for rope clamp wo/nut
7	1	pc	30-61-3486	Nut PE for rope clamp
8	1	pc	99-50-0120	Cable clamp 5mm 3/16" galv. DIN 741

### 5.2.2 excl. net

60-47-3373				Fresh air inlet cpl. CL 2400 N excl. net
	Quantity	Unit	Code No.	Description
1	1	pc	60-47-3378	Fresh air inlet CL - 2400 - N excl. net
2	0.40	pc	99-50-3810	Silicone transparent 300 ml
3	8	pc	99-10-3958	Chipboard screw 5,0 x 50 ABC-Spax pan head SST
4	8	pc	99-98-3782	Dowel S 6
5	1.20	m	99-50-1004	Rope Perlon PP 3 mm white
6	1	pc	30-61-3485	Plug PE for rope clamp wo/nut
7	1	pc	30-61-3486	Nut PE for rope clamp
8	1	pc	99-50-0120	Cable clamp 5 mm 3/16" galv. DIN 741

**5.2.3 Mounting set**

60-47-3385				Mounting set CL 2400 N
	Quantity	Unit	Code No.	Description
1	20	m	60-40-3106	Wire rope 4mm SST 1.4301
2	2	pc	99-50-1010	Turnbuckle M8 x 110 galv.
3	8	pc	60-60-0000	Idler pulley 107 mm 45deg PVR
4	2	pc	60-60-0001	Idler pulley 107 mm 90deg PVR
5	10	pc	60-60-0002	Bracket for idler pulley PVR
6	2	pc	60-47-3379	Tension spring 3,0 x 39 x 187 C DIN 17223
7	10	pc	99-10-3710	Rod threaded M10 x 1000 DIN 975 galv.
8	30	pc	99-10-3783	Hexagon wood screw 10 x 80 DIN 571-ST galv.
9	30	pc	99-98-3783	Dowel S 12
10	10	pc	20-90-3759	Washer flat 13 x 50 x 2 galv.
11	30	pc	99-20-1029	Hexagon nut M10 galv. DIN 555
12	10	pc	99-50-0120	Cable clamp 5 mm 3/16" galv. DIN 741
13	2	pc	99-20-1114	Lifting eye nut M8 DIN 582 galv.
14	2	pc	99-10-1046	Hexagon head screw M8 x 16 galv. DIN 558
15	2	pc	60-41-5017	Reducing block
16	4	pc	99-50-0502	Thimble SST 6mm f/cable 5mm
17	2	pc	10-93-1628	Lifting eye bolt galv. 2/50x18x7,0

## 5.2.3.1 Detailed drawing of the assembly kit accessories

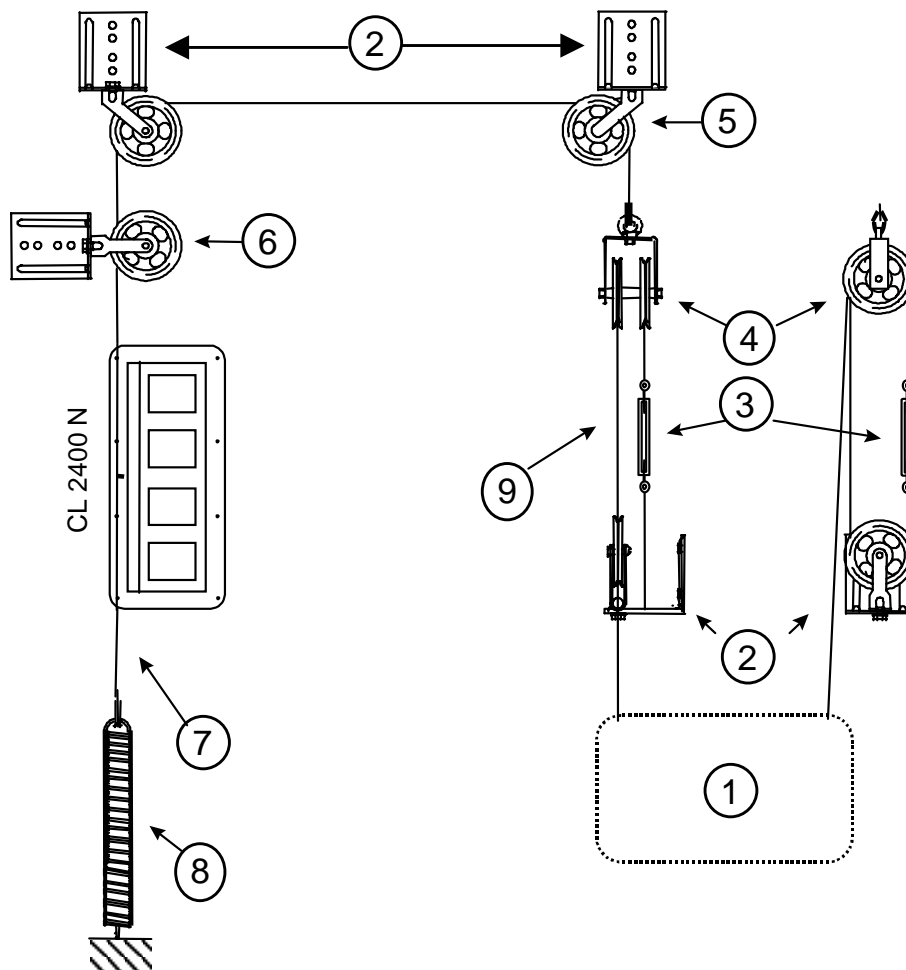

1. Driving mechanism
2. Console for PVR roll
3. Wire stretcher
4. Reducing block
5. Idler pulley / 107 mm 45° PVR
6. Idler pulley / 107 mm 90° PVR
7. Tensioning rod
8. Traction spring
9. Wire rope 4 mm

## 5.2.3.2 Assembly of idler pulleys with different strains

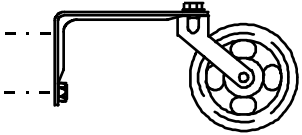
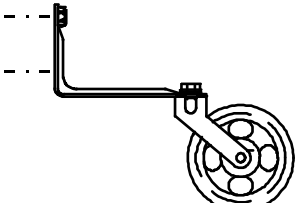
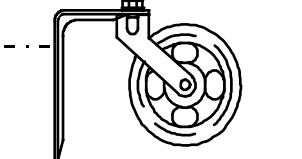
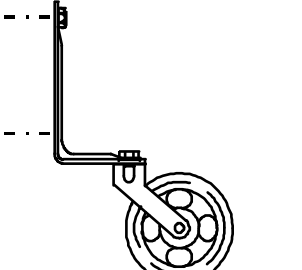
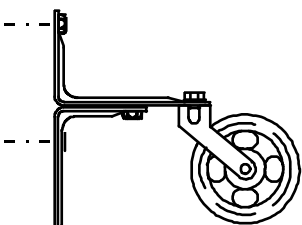
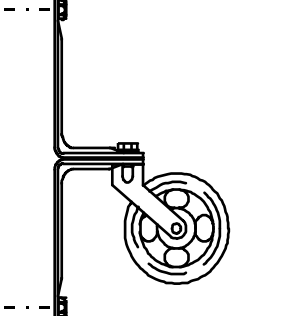
	<p>The iron mounting of the roll is mounted in the outermost hole of the long side of the wall fitting. The wall fitting is attached by means of two bolts and mounted as shown.</p> <p>Max. wire rope load: 1500 N (150 kg)</p>
	<p>With the fitting being in the position indicated:</p> <p>Max. wire rope load: 2000 N (200 kg)</p>
	<p>The iron mounting of the roll is mounted in the outermost hole of the short side of the wall fitting. The wall fitting is attached by means of two bolts and mounted as shown.</p> <p>Max. wire rope load: 3000 N (300 kg)</p>
	<p>With the fitting being in the position indicated:</p> <p>Max. wire rope load: 4000 N (400 kg)</p>
	<p>Two wall fittings screwed together with two bolts:</p> <ul style="list-style-type: none"> <li>- The iron mounting of the roll is mounted in the outermost hole of the long side of the wall fitting. The wall fittings are attached by means of three bolts and mounted as shown.</li> </ul> <p>Max. wire rope load: 5000 N (500 kg)</p>
	<ul style="list-style-type: none"> <li>- The iron mounting of the roll is mounted in the outermost hole of the short sides of the wall fittings. The wall fittings are attached by means of two bolts and mounted as shown.</li> </ul> <p>Max. wire rope load: 6000 N (600 kg)</p> <p>Fittings which are screwed together are used for mounting on nonrigid or weak walls to increase the contact surface.</p>

